

SIM and Memory Card Socket Connector

TS3

Applications | Mobile phone, Computer, Laptop, Medical equipment, Video recorder, Smart Car

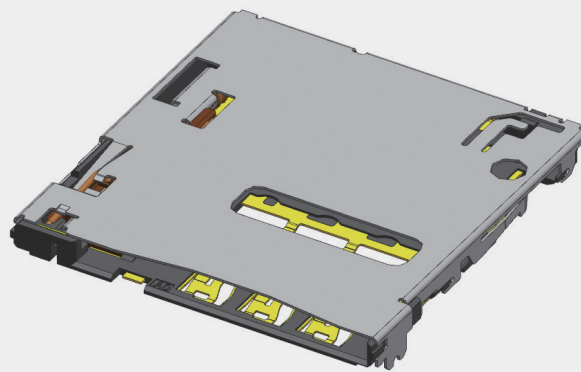

- ▶ MICRO SIM Card Socket
- ▶ Push In – Push Out (Simple Installation)
- ▶ Application structure Card Detect Switch

Specifications

Current Rating	Contact Resistance	Insulation Resistance	Dielectric Strength	Temperature Range
0.5A/Pin	CONTACT 150mΩ [Max.] DETECT 200mΩ [Max.]	1,000MΩ [Min.]	AC 500V	-40°C ~ 85°C

Mating Size & Product No.

PINS	PITCH	WIDTH	HEIGHT	LENGTH	CODE
6	2.54	15.98	1.27	15.45	SS254-C06B-C13-B

SIM and Memory Card Socket Connector

TS3

Applications | Mobile phone, Computer, Laptop, Medical equipment, Video recorder, Smart Car

Product Specification

Ratings	Rated current	0.5A/Pin	Operating temperature range	-40°C to +85°C 1	Storage temperature range	-5°C to +40 °C (With packing)
	Rated voltage	AC 125V	Operating humidity range	10% to 80% RH 2	Storage humidity range	65%RH

1) Including terminal temperature rise.

2) Storage area is to be free of corrosive gases and dew formation.

Items	Specifications	Conditions
1. Contact resistance	CONTACT - 150mΩ [Max.] DETECT - 200mΩ [Max.]	- Open circuit voltage: 20mV. - Test current: 10mA.
2. Insulation resistance	1,000MΩ [Min.]	- Test voltage: 500V d.c. - Test time: 1 minute ± 5 seconds.
3. Withstanding voltage	No flashover or dielectric breakdown	AC 500V for 1minute
4. Card Insertion force & Withdrawal force	Initial : 500 ±200 gf After : 500 ±200 gf	- Push-pull gauge at 25±3m/min speed.
5. Vibration	- MAX. Change from Initial contact resistance 40mΩ MAX.	- Vibration frequency range : 10-55-10Hz - Total amplitude : 1.52mm - Sweep time : 30sec - Duration : 2h each (6h in total)
6. Durability	- MAX. Change from Initial contact resistance 40mΩ MAX. - Card Insertion Force & withdrawal force 500 ±200 gf	1) Attach and detach 500 times. 2) Attach and detach 2,000 times. 3) Reattach the 0.7T SD/SIM card tested in Sample No.2 and attach/detach an additional 3,000 times
7. Temperature and Humidity cycle	- MAX. Change from Initial contact resistance 40mΩ MAX. - Insulation resistance : 100MΩ Min	- 40±3(°C) : 30 minutes → 85±2(°C) : 30 minutes, 96 cycles
8. Humidity	- MAX. Change from Initial contact resistance 40mΩ MAX. - Insulation resistance : 100MΩ Min	- Temperature : 40°C±2°C - Relative humidity : 90% RH to 95% RH - Duration : 96hr
9. Salt mist	- MAX. Change from Initial contact resistance 40mΩ MAX. - Insulation resistance : 100MΩ Min	- Salt water concentration : 5±1% Weight ratio - Temperature : 35°C±2°C - Duration : 72h
10. Heat	- MAX. Change from Initial contact resistance 40mΩ MAX. - Insulation resistance : 100MΩ Min	- Temperature : 105±2°Ctio - Duration : 96h

Materials / Finish

Part	Materials	Finish	UL Regulation
Base	LCP	Black	UL94V-0
Terminal	Copper Alloy	Au, Ni plated	-
Cover	Stainless Steel	Au, Ni plated	-
CAM Slider	Copper Alloy	Ni plated	-
CAM Plate	LCP	Black	UL94V-0
CAM Stick	Stainless Steel	-	-
Spring	Stainless Steel	-	-
Stopper	Stainless Steel	-	-

SIM and Memory Card Socket Connector

TS3

Applications | Mobile phone, Computer, Laptop, Medical equipment, Video recorder, Smart Car

FEATURES AND ADVANTAGES

► CARD INSERT

- Easy card installation (Push In – Push Out)
- Improving product quality reliability

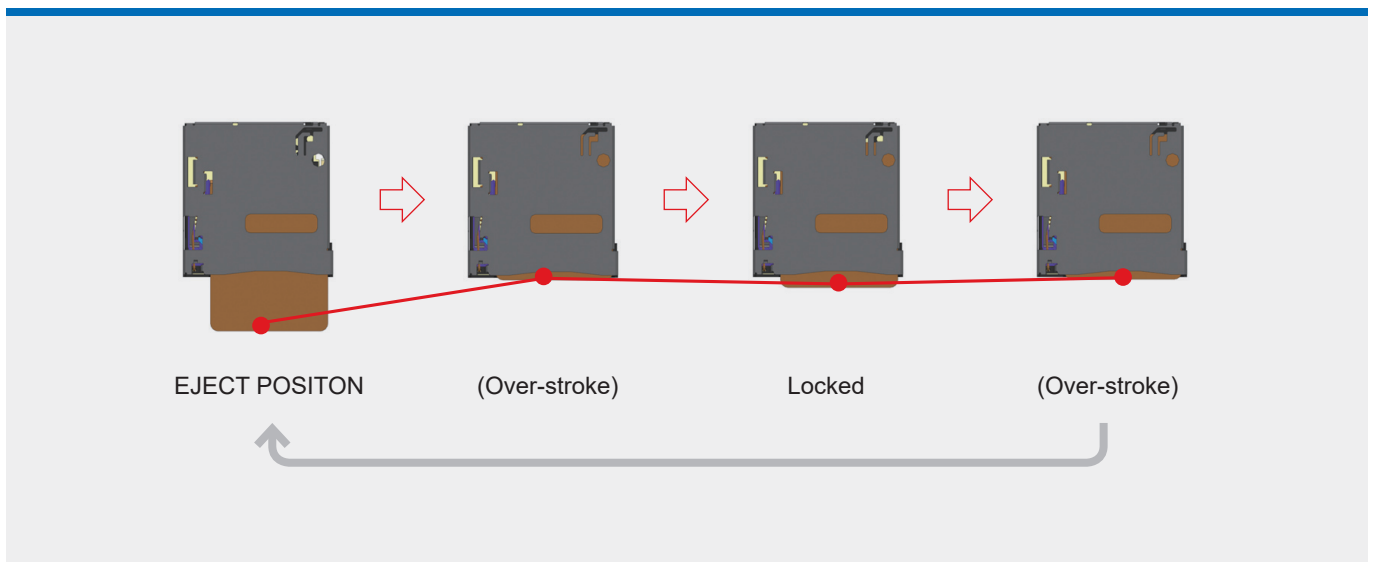

► CARD DETECTION

- Strengthen contact stability
- Improving product quality reliability

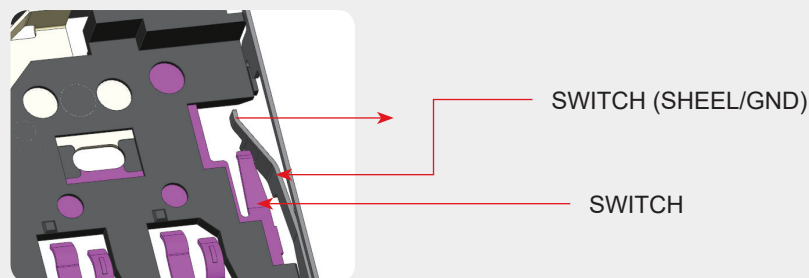

SIM and Memory Card Socket Connector



Applications | Mobile phone, Computer, Laptop, Medical equipment, Video recorder, Smart Car

Product Drawing

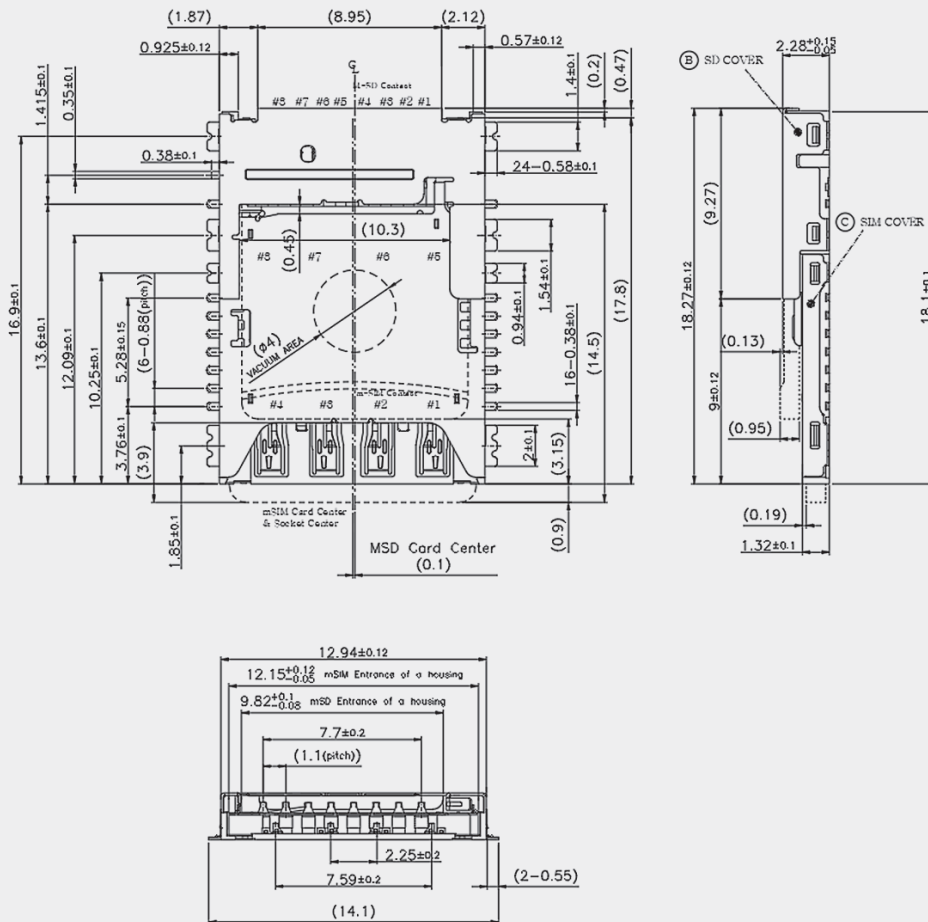
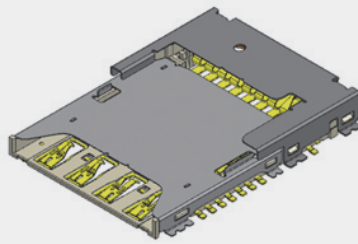

SIM and Memory Card Socket Connector



Applications | Mobile phone, Computer, Laptop, Medical equipment, Video recorder, Smart Car

Recommended PCB Dimensions

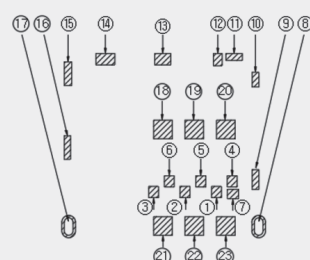
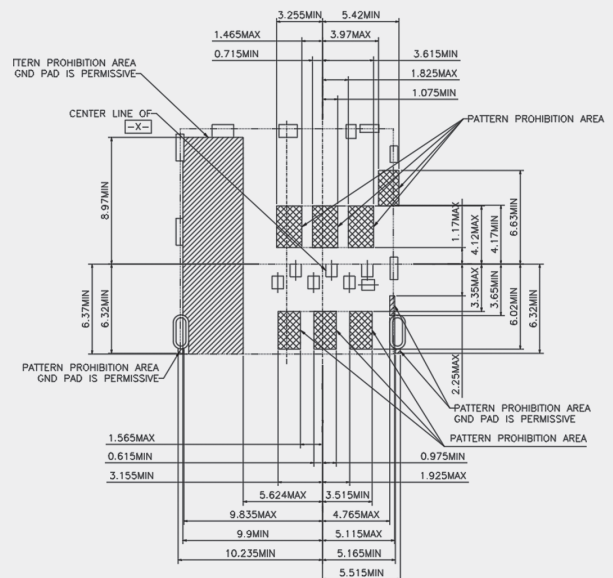
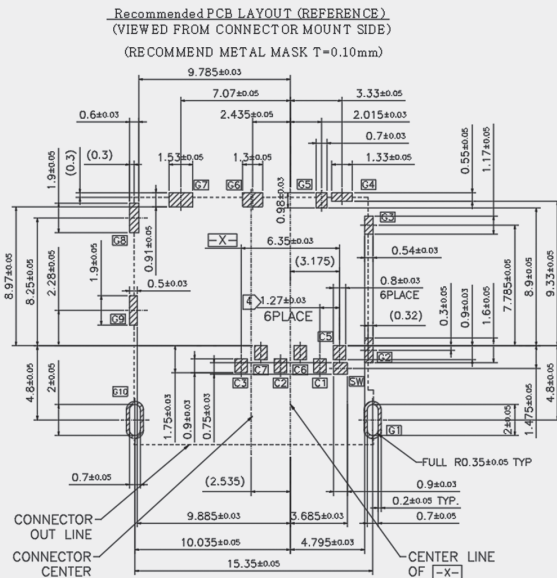

Connector Pin Assignments

No.	Pin name	Description
①	C1	Vcc of SIM
②	C2	RST of SIM
③	C3	CLK of SIM
④	C5	GND of SIM
⑤	C6	Vpp of SIM
⑥	C7	I/O of SIM
⑦	SW	Detection Switch
⑧-⑩	GND	Shell Ground
⑪-⑬	NC	Not connected

SIM CARD PAD LAYOUT1

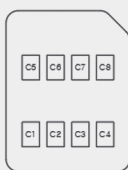

SIM Card Pin Assignments

PIN#	Item
C1	Vcc
C2	RST
C3	CLK
C4	Reserved
C5	GND
C6	Vpp
C7	I/O
C8	Reserved

