

# 1) 025 SLD 6M ASSY

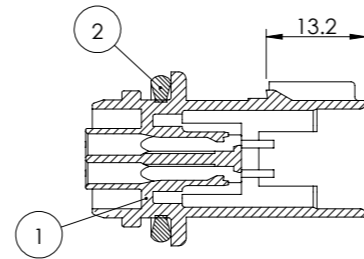

SECTION A-A

# 2) 025 SLD 6M TPA

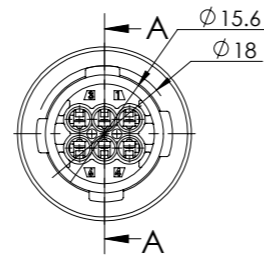
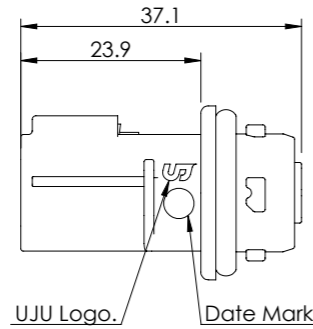
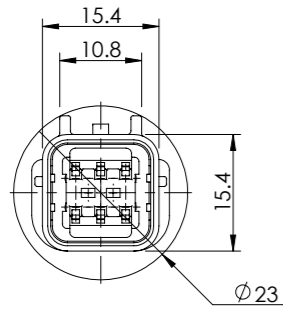
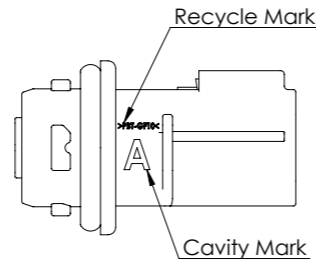
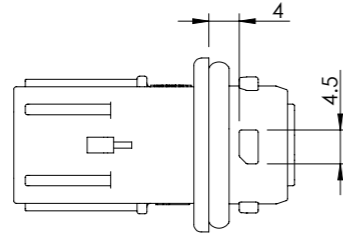
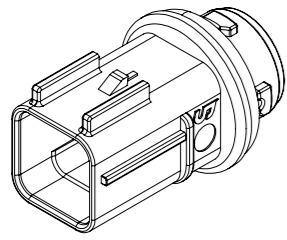
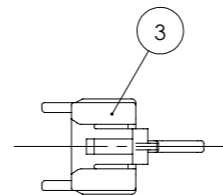
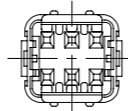
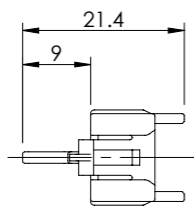
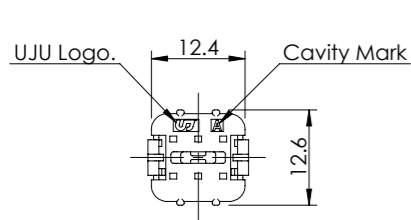
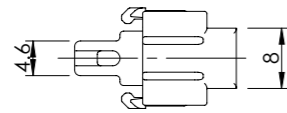
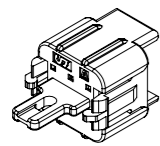

SECTION 3

## Applicable PANEL hole size

- NOTE -
1. Panel thickness : 2<sup>0</sup>/<sub>-0.1</sub>mm
  2. C and R shape tolerance is +0.1
  3. The general tolerance of the panel hole is ±0.1

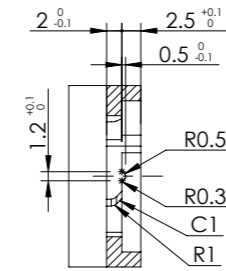
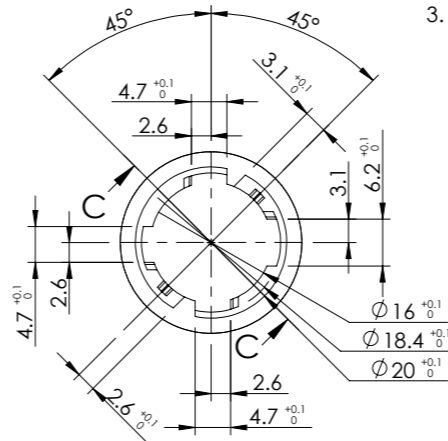

SECTION C-C

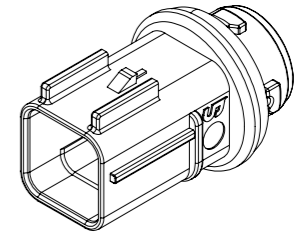

ISO VIEW

- NOTE -

1. This is a WATERPROOF connector.
2. Before using, check the HARMFUL CRACK, BURR, etc.
3. General Tolerance : See TOLERANCE table
4. Delivery condition : TPA 1st. lock position
5. All letters shall be clear and legible.
6. Matching Connector  
- 025\_SLD\_6F\_ASSY [KH2100067]

7. ASSY Parts.

- Terminal

Series	Applicable wire(SQ)	Description	Part No.
025	AESSXF 0.22	025_SLD_M_TML_S	KH2000035-20
	AESSXF 0.3 ~ 0.5	025_SLD_M_TML_M	KH2000035-21

- Wire Seal

Series	Applicable wire(SQ)	Description	Part No.
025	ø1.2 ~ ø1.3	025_SLD_Wire Seal_S	KD0000002
	ø1.4 ~ ø1.5	025_SLD_Wire Seal_M	KD0000004
	ø1.6 ~ ø1.7	025_SLD_Wire Seal_L	KD0000005
	CLOSED SEAL	025_SLD_Dummy Seal	KD0000003

No.	Description	Part No.	Material	Finish / Color	Q'ty
4	025_SLD_6M_TPA	KH2100070-10	PBT-GF30	Natural	1 - -
3	025_SLD_6M_Packing Seal	KN0000022	Si-Rubber	Blue	- 1 1
2	025_SLD_6M_HSG_GR	KM2100072-30	PBT-GF10	Gray	- 1 -
1	025_SLD_6M_HSG_BK	KM2100072-20	PBT-GF10	Black	- - 1

Part No.	Description
KH2100070-10	025_SLD_6M_TPA
KH2100071-30	025_SLD_6M_ASSY_GY
KH2100071-20	025_SLD_6M_ASSY_BK

TOLERANCE								
10MAX	30MAX	50MAX	70MAX	100MAX	120MAX	250MAX	250VR	ANGLE
±0.15	±0.20	±0.30	±0.40	±0.50	±0.75	±0.9	±1.4	±0.5°

DRWN JH. LEE	CHKD KH. PARK	APVD CY. CHOI	NAME <b>025_SLD_6M_ASSY</b>		
TOLERANCES UNLESS OTHERWISE SPECIFIED			UNIT <b>MM</b>	MATERIAL <b>PBT+GF10</b>	
THIRD ANGLE PROJECTION			FINISH/COLOR <b>BLACK</b>	CUSTOMER <b>KH2100071</b>	
PRODUCT SPEC			APPLICATION SPEC	WEIGHT	DRAWING NO. <b>KH2100071</b>
LOC	RESTRICTED TO	SIZE <b>A3</b>	SCALE <b>-</b>	SHEET <b>1 of 1</b>	REV <b>A</b>