

REV	REVISION RECORD	DATE	DRWN	CHKD	APVD
A	RELEASED	16 JUL '19	JK	KH	CY

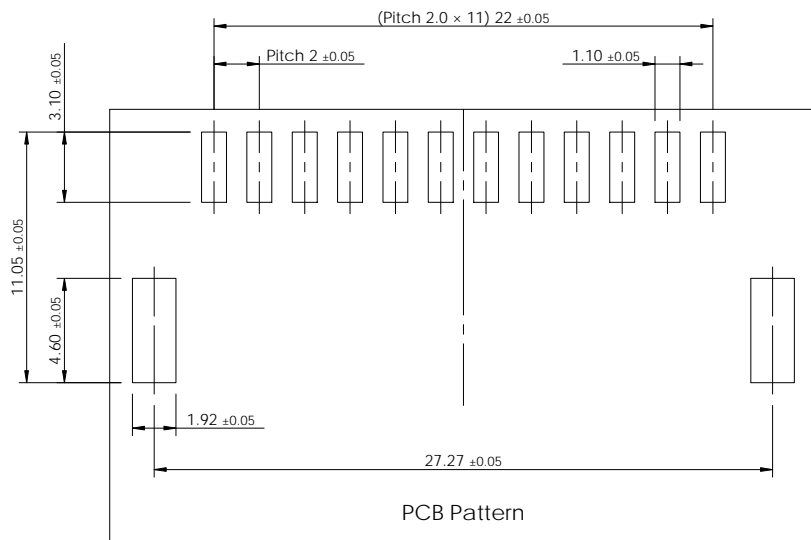
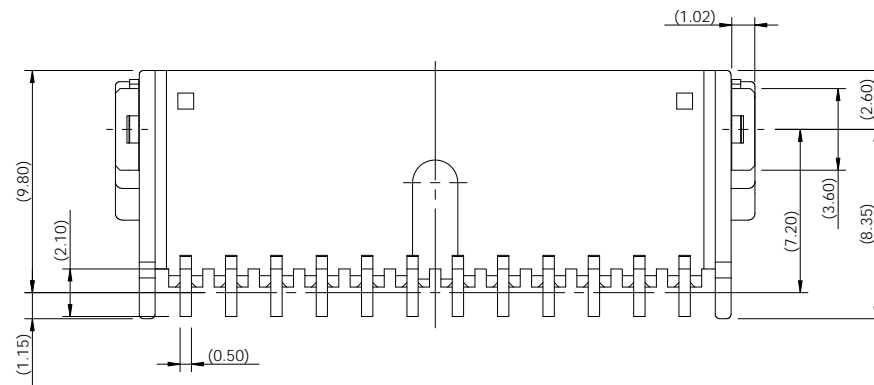
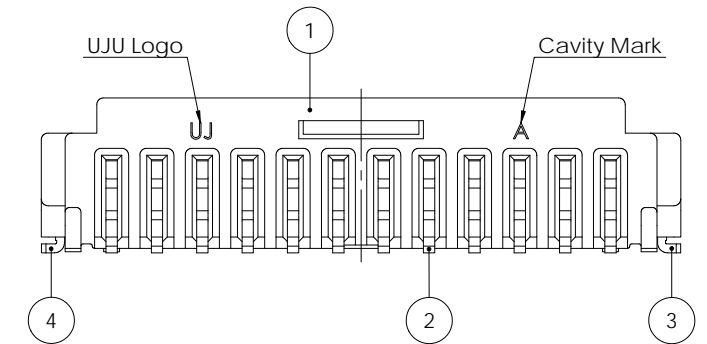
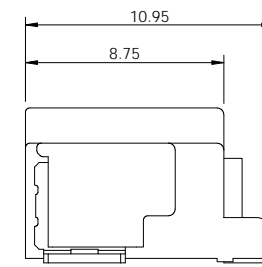
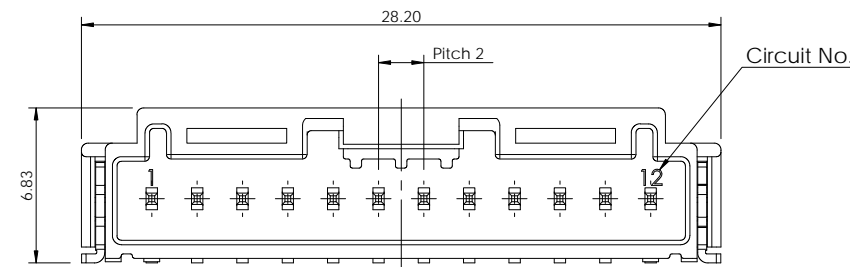
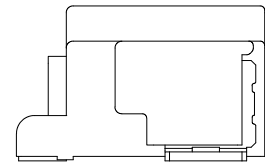
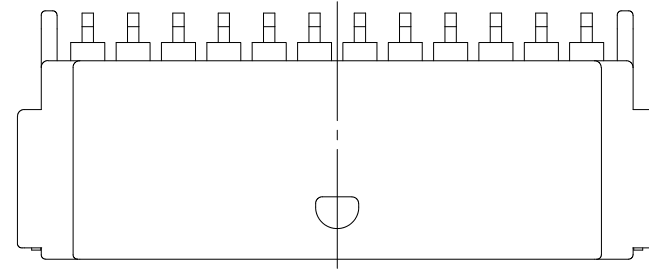
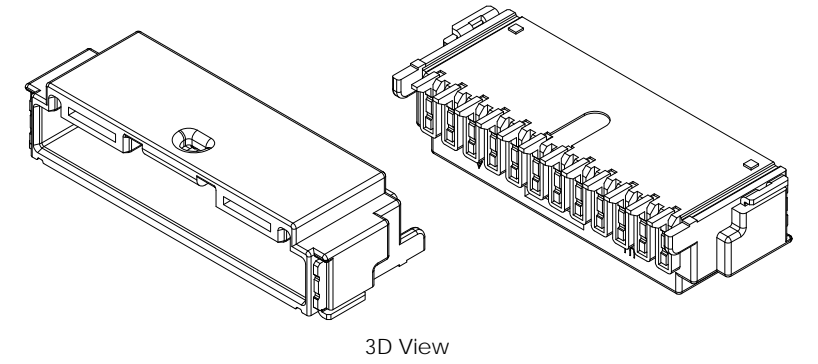

-Note-
1. General Tolerance : ±0.30

No.	Description	Material	Finish / Color	Q'ty	Ass'y Part No.
4	020 S SMT Solder Peg HZT-R	Copper Alloy	Post-Tin	1	KH1800112-20
3	020 S SMT Solder Peg HZT-L	Copper Alloy	Post-Tin	1	KH1800112-10
2	020 S SMT Tab TML HZT	Copper Alloy	Post-Tin	12	12
1	020_S_BL_SMT_12M_H_HSG	PA9T-GF30	Black	1	-
			Natural	-	1

TOLERANCES UNLESS OTHERWISE SPECIFIED		UNIT MM	THIRD ANGLE PROJECTION	DRWN JK. HWANG	CHKD KH. PARK	APVD CY. CHOI	NAME C_020_S_BL_SMT_12M_H_ASSY
0	±						
0.0	±						
0.00	±						
0.000	±						
0.0000	±						
ANGLES	±						
PRODUCT SPEC	APPLICATION SPEC	WEIGHT					
				(주)우주 일렉트로닉스 UJU Electronics co.,Ltd.		DRAWING NO KH1800112	
LOC	RESTRICTED TO	SIZE A3	SCALE 3:1	SHEET 1 of 1	REV A		