

REV	REVISION RECORD	DATE	DRWN	CHKD	APVD
A	RELEASED	28 MAY '19	JK	KH	CY

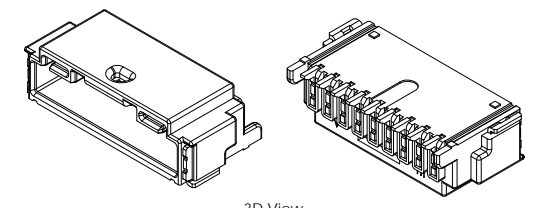

3D View

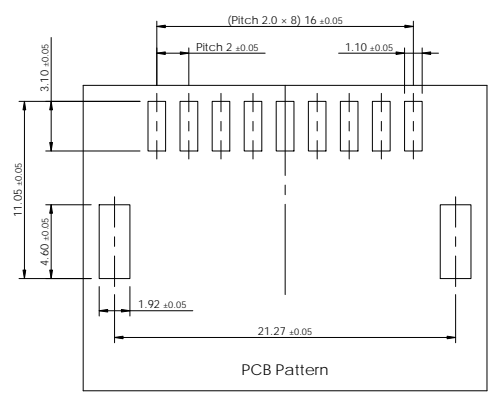
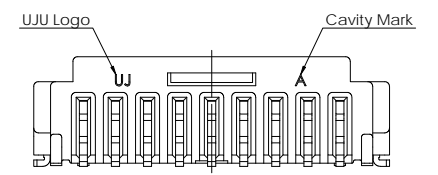
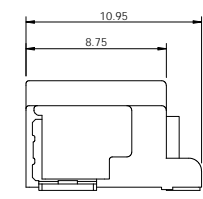
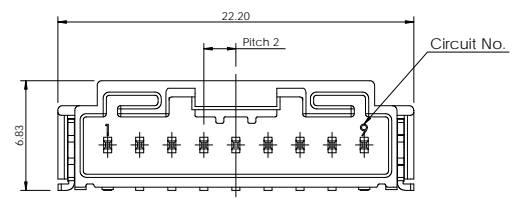
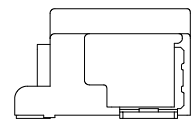
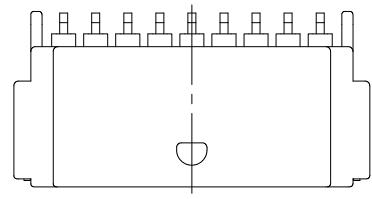

PCB Pattern

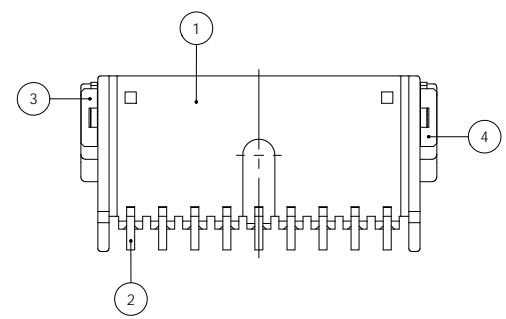

-Note-
1. General Tolerance : ±0.30

No.	Description	Material	Finish / Color	Q'ty	Ass'y Part No.
4	020 S SMT Solder Peg HZT-R	Copper Alloy	Post-Tin	1	1
3	020 S SMT Solder Peg HZT-L	Copper Alloy	Post-Tin	1	1
2	020 S SMT Tab TML HZT	Copper Alloy	Post-Tin	9	9
1	020_S_BL_SMT_9M_H_HSG	PA9T-GF30	Black	1	-
			Natural	-	1

TOLERANCES UNLESS OTHERWISE SPECIFIED	UNIT MM
0 ±	THIRD ANGLE PROJECTION
0.0 ±	MATERIAL
0.00 ±	FINISH/COLOR
0.000 ±	WEIGHT
0.000 ±	APPLICATION SPEC
ANGLES ±	PRODUCT SPEC

DRWN JK. HWANG	NAME		DRAWING NO.	
CHKD KH. PARK	020_S_BL_SMT_9M_H_ASSY		KH1700152	
APVD CY. CHOI	CUSTOMER	DRAWING		
MATERIAL SEE TABLE		LOC	RESTRICTED TO	SIZE
FINISH/COLOR SEE TABLE		SCALE		SHEET
WEIGHT		3:1		1 OF 1

