

REV	REVISION RECORD	DATE	DRWN	CHKD	APVD
A	RELEASED	22 APR '19	JK	KH	CY
B	CHANGED (RD-2021-063)	12 MAY '21	JK	KH	CY

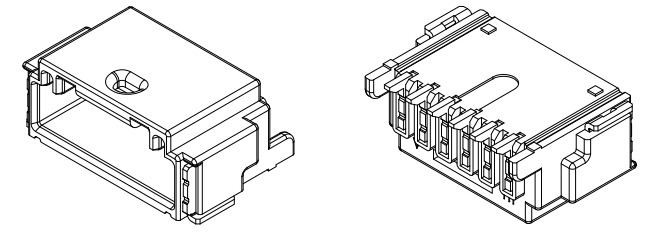

3D View

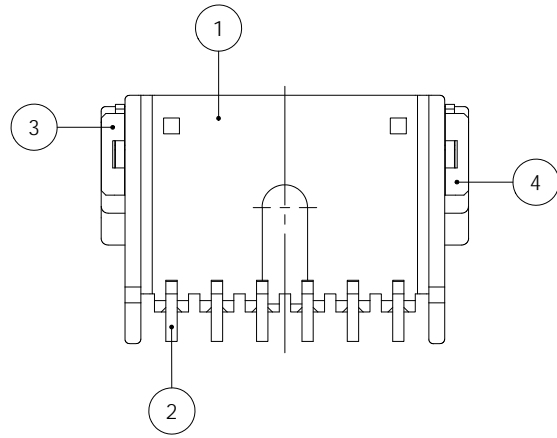
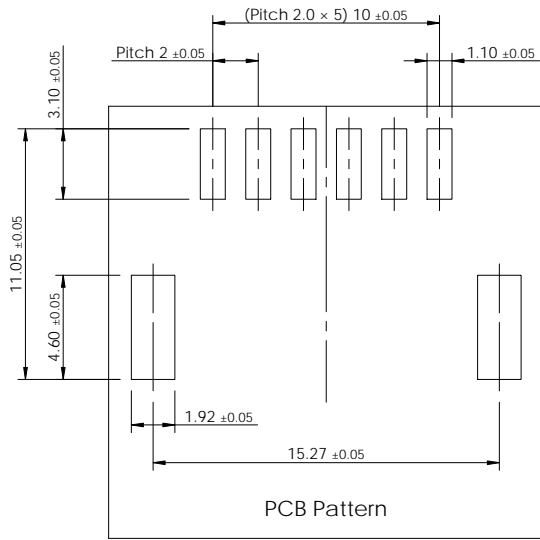
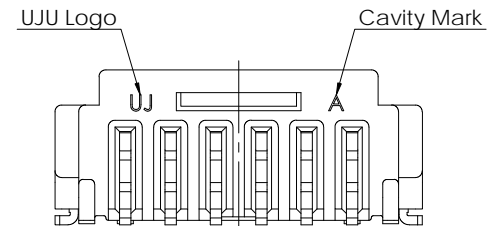
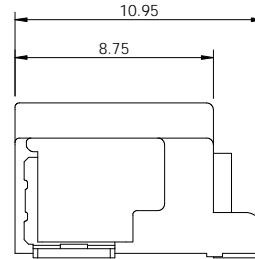
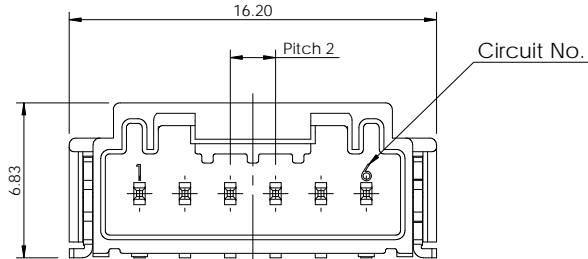
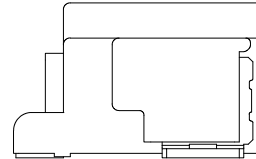
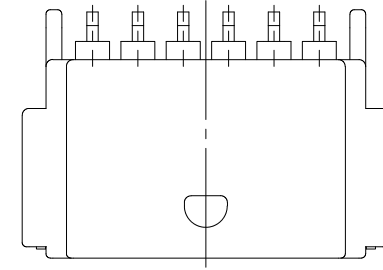

-Note-

1. General Tolerance : ±0.30

No.	Description	Material	Finish / Color	Q'ty
4	020 S SMT Solder Peg HZT-R	Copper Alloy	Post-Sn	1 1 1 1
3	020 S SMT Solder Peg HZT-L	Copper Alloy	Post-Sn	1 1 1 1
2	020 S SMT Tab TML HZT	Copper Alloy	Post-Sn	6 6 6 6
1	020_S_BL_SMT_6M_H_HSG_GN	PA9T-GF30	(B) Green	1 - - -
	020_S_BL_SMT_6M_H_HSG_RE	PA9T-GF30	(B) Red	- 1 - -
	020_S_BL_SMT_6M_H_HSG_BK	PA9T-GF30	Black	- - 1 -
	020_S_BL_SMT_6M_H_HSG_NR	PA9T-GF30	Natural	- - - 1

Description	Part No.
020_S_BL_SMT_6M_H_HSG_GN	KH1700146-70
020_S_BL_SMT_6M_H_HSG_RE	KH1700146-60
020_S_BL_SMT_6M_H_HSG_BK	KH1700146-20
020_S_BL_SMT_6M_H_HSG_NR	KH1700146-10

TOLERANCES UNLESS OTHERWISE SPECIFIED		UNIT MM	THIRD ANGLE PROJECTION	DRWN JK. HWANG	CHKD KH. PARK	APVD CY. CHOI	NAME 020_S_BL_SMT_6M_H_ASSY
0 ±	0.0 ±			MATERIAL SEE TABLE	CUSTOMER DRAWING		
0.00 ±	0.000 ±			FINISH/COLOR SEE TABLE	DRAWING NO KH1700146		
0.0000 ±	ANGLES ±			WEIGHT	LOC	RESTRICTED TO	SIZE A3
PRODUCT SPEC	APPLICATION SPEC				SCALE 3:1	SHEET 1 of 1	REV B

