

REV	REVISION RECORD	DATE	DRWN	CHKD	APVD
A	RELEASED	14 JAN '19	JK	HS	SH

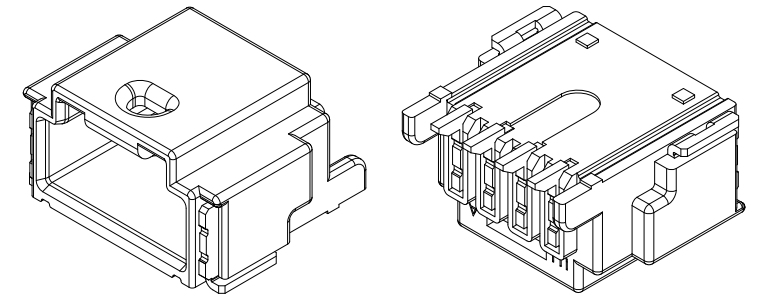

3D View

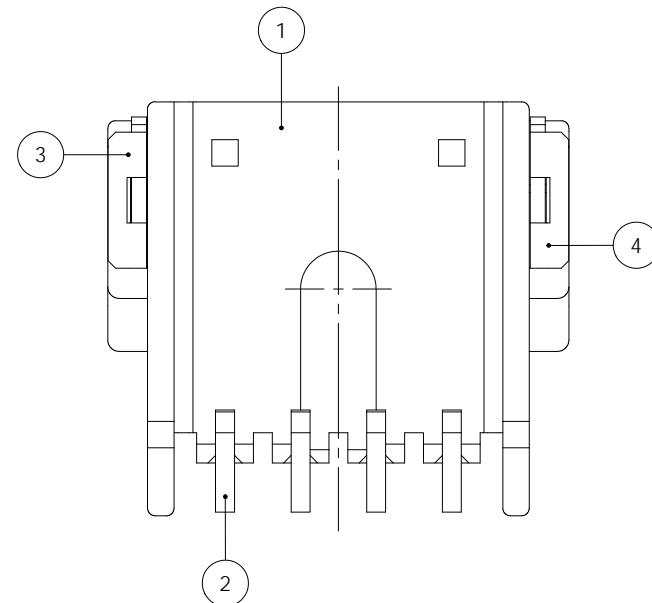
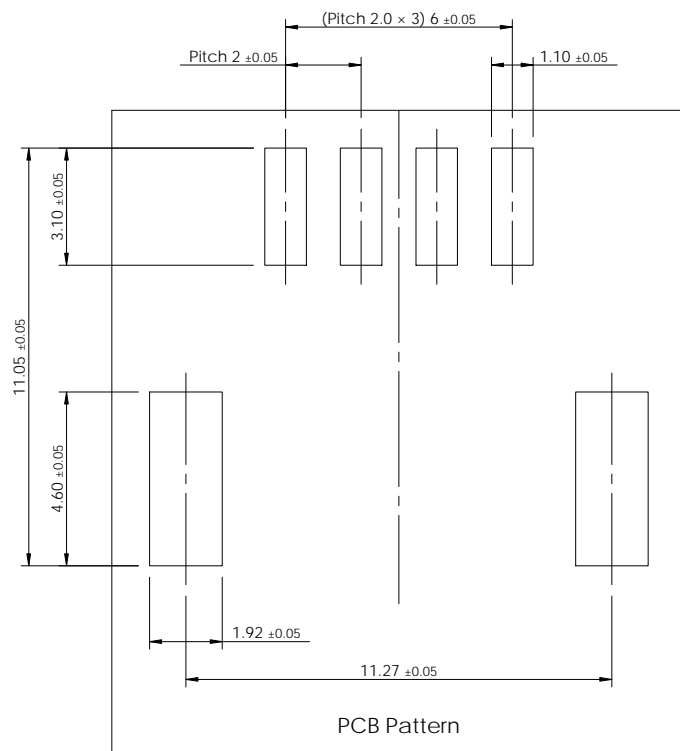
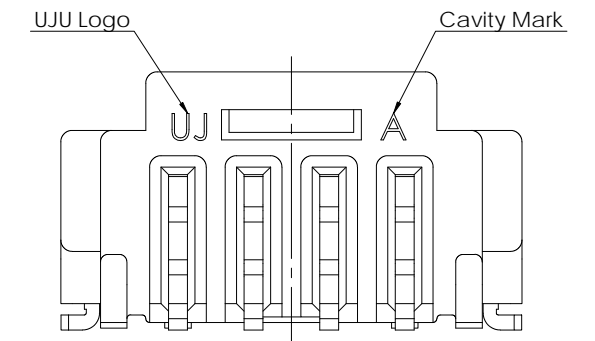
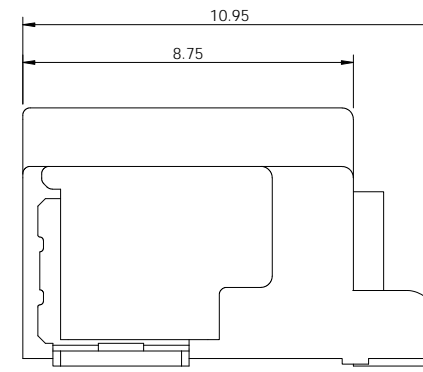
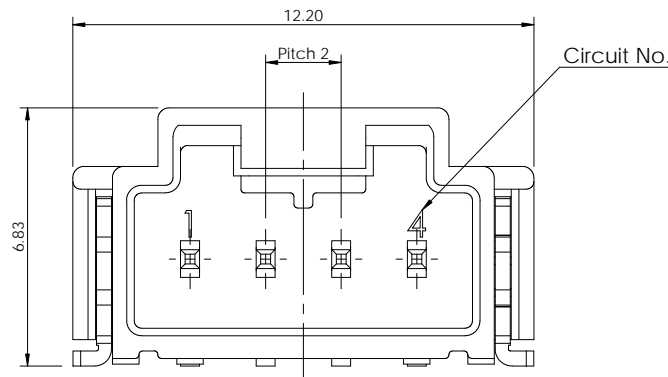
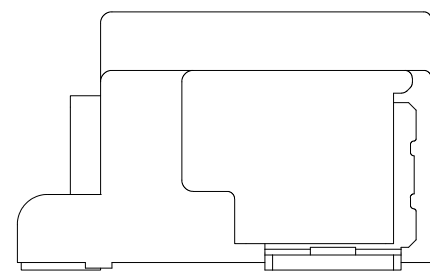
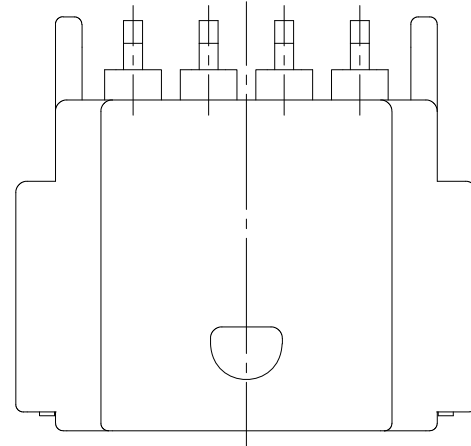

-Note-
1. General Tolerance : ±0.30

No.	Description	Material	Finish / Color	Q'ty	Ass'y Part No.
4	020 S SMT Solder Peg HZT-R	Copper Alloy	Post-Sn	1	1
3	020 S SMT Solder Peg HZT-L	Copper Alloy	Post-Sn	1	1
2	020 S SMT Tab TML HZT_Au	Copper Alloy	Post-Au/Sn	4	4
1	020_S_BL_SMT_4M_H_HSG	PA9T-GF30	Black	1	-
			Natural	-	1

TOLERANCES UNLESS OTHERWISE SPECIFIED		UNIT MM	THIRD ANGLE PROJECTION	DRWN JK. HWANG	CHKD HS. LEE	APVD SH. LEE	NAME 020_S_BL_SMT_4M_H_ASSY_Au	
0	±			MATERIAL SEE TABLE		FINISH/COLOR SEE TABLE		
0.0	±			WEIGHT		CUSTOMER DRAWING		DRAWING NO KH1800019
0.00	±			LOC	RESTRICTED TO	SIZE A3	SCALE 5:1	SHEET 1 of 1
0.000	±							REV A
0.0000	±							
ANGLES	±							

