

REV	REVISION RECORD	DATE	DRWN	CHKD	APVD
A	RELEASED	22 APR '19	JK	KH	CY
B	REVISED	23 OCT '19	JK	KH	CY

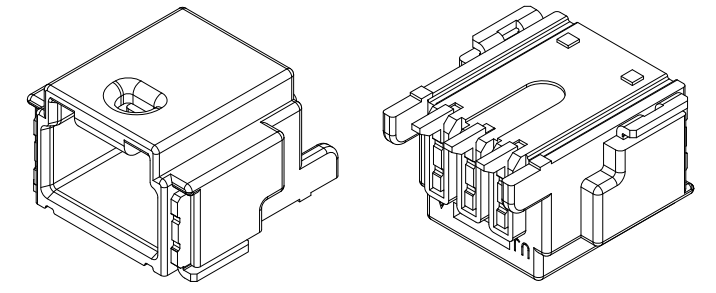

3D View

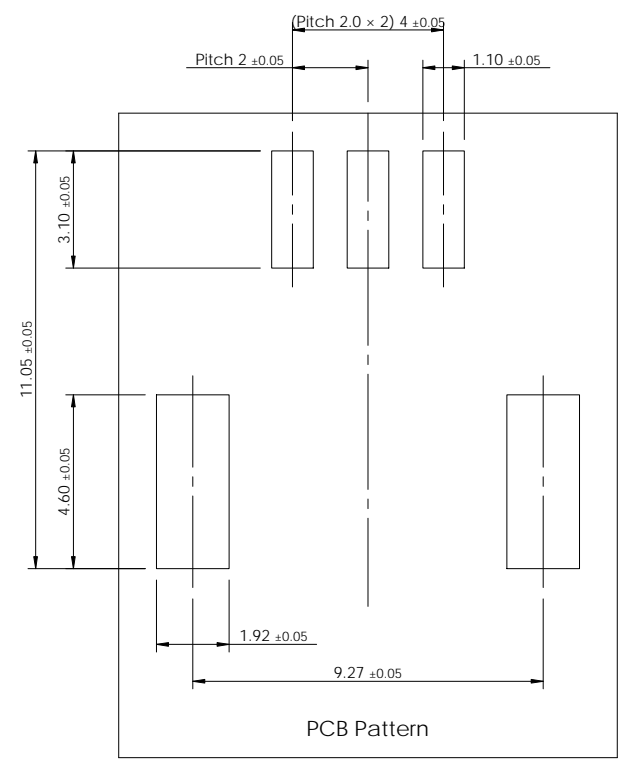
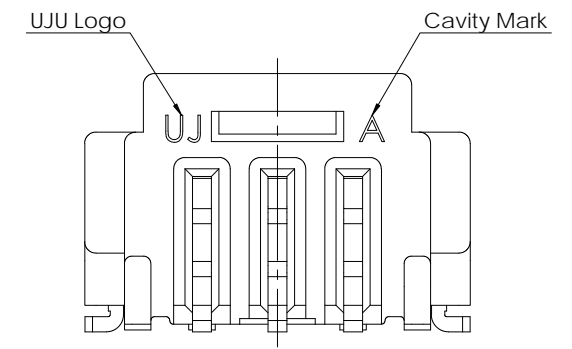
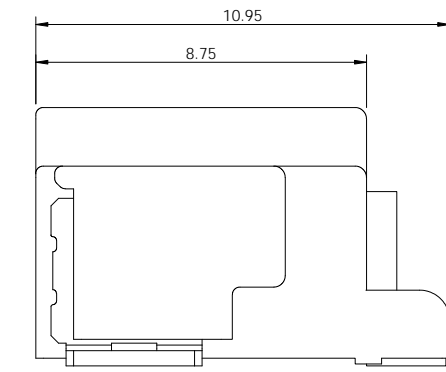
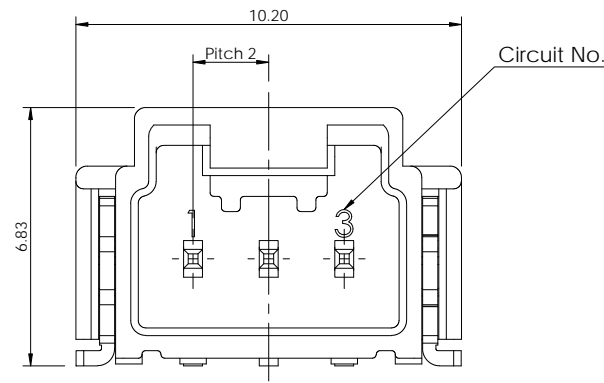
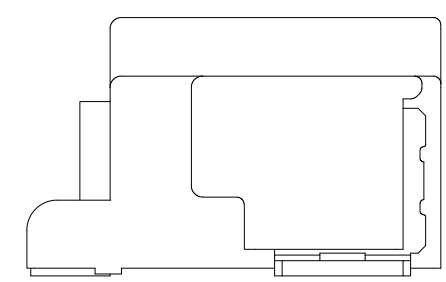
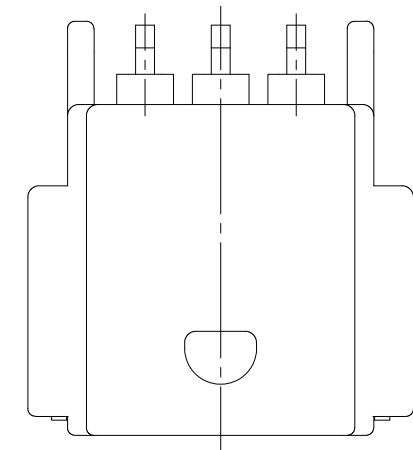

PCB Pattern

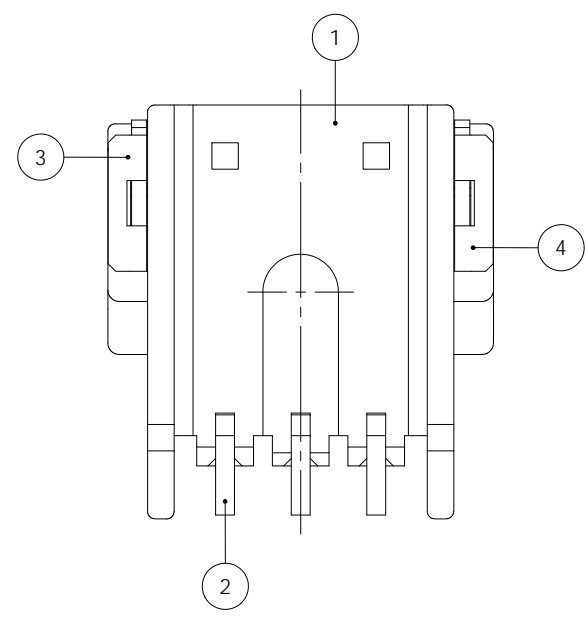

-Note-  
1. General Tolerance : ±0.30

No.	Description	Material	Finish / Color	Q'ty	KH1700140-60	KH1700140-20	KH1700140-10	Ass'y Part No.
4	020 S SMT Solder Peg HZT-R	Copper Alloy	Post-Tin	1	1	1	1	
3	020 S SMT Solder Peg HZT-L	Copper Alloy	Post-Tin	1	1	1		
2	020 S SMT Tab TML HZT	Copper Alloy	Post-Tin	3	3	3		
1	020_S_BL_SMT_3M_H_HSG	PA9T-GF30	Red (B)	1	-	-		
			Black	-	1	-		
			Natural	-	-	1		

TOLERANCES UNLESS OTHERWISE SPECIFIED	0	±	THIRD ANGLE PROJECTION	DRWN	JK. HWANG	NAME	020_S_BL_SMT_3M_H_ASSY
	0.0	±		CHKD	KH. PARK		
ANGLES	0.000	±	PRODUCT SPEC	APVD	CY. CHOI	CUSTOMER DRAWING	KH1700140
	0.0000	±		APPLICATION SPEC	WEIGHT		
UNIT		MM	FINISH/COLOR		SEE TABLE	DRAWING NO	
MATERIAL		SEE TABLE	LOC		RESTRICTED TO	SIZE	A3
SCALE		5:1	SHEET		1 of 1	REV	
REV		B					