

REV	REVISION RECORD	DATE	DRWN	CHKD	APVD
A	RELEASED	19 JUL '18	JK	SH	MJ
B	REVISED	24 JUL '19	JK	KH	CY

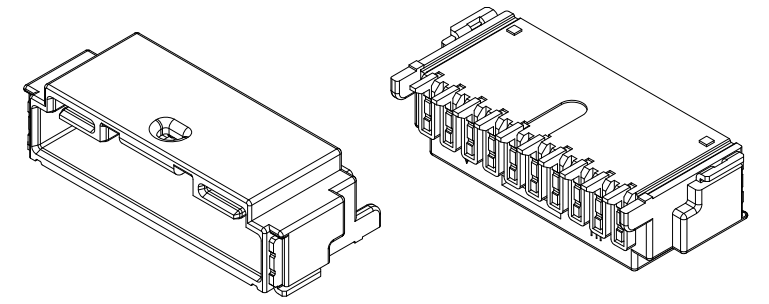

3D View

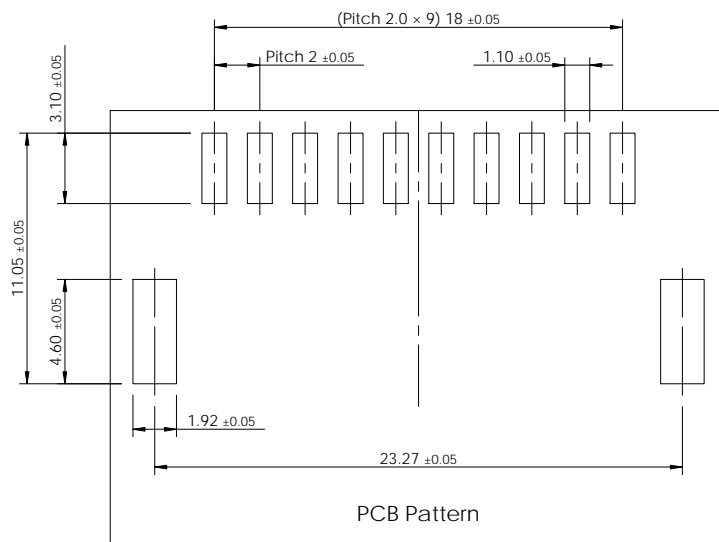
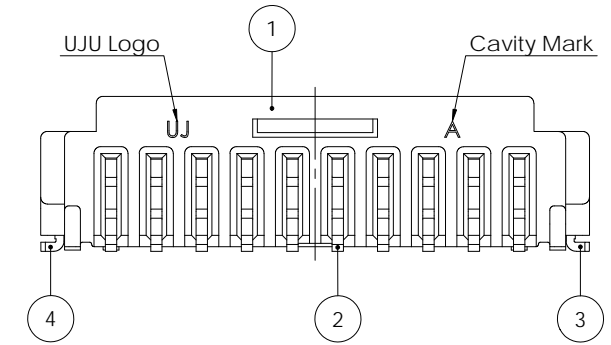
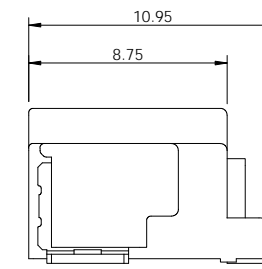
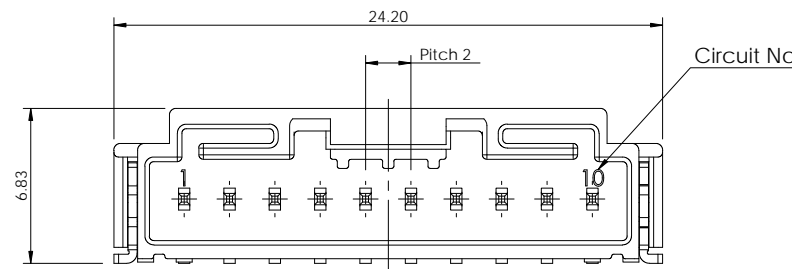
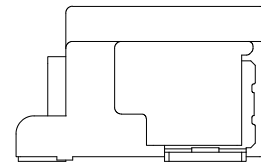
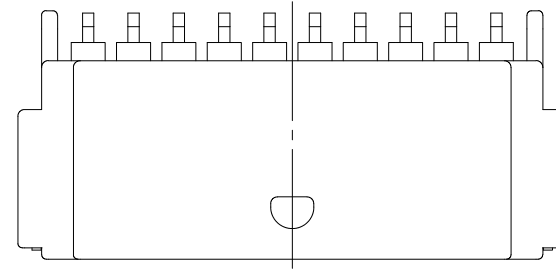

PCB Pattern

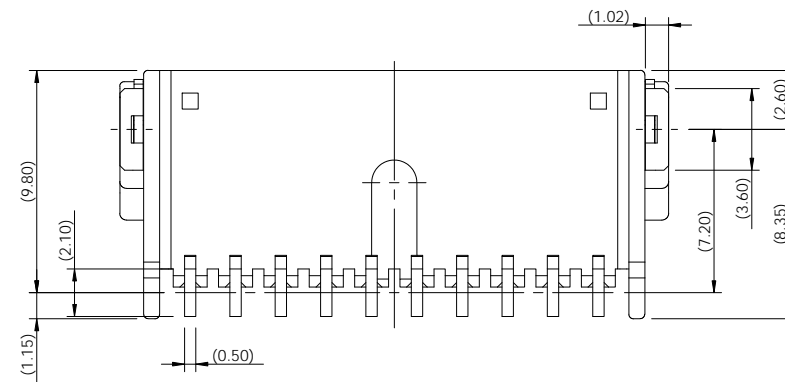

-Note-

1. General Tolerance : ±0.30

No.	Description	Material	Finish / Color	Q'ty
4	020 S SMT Solder Peg HZT-R	Copper Alloy	Post-Sn	1 1 1 1
3	020 S SMT Solder Peg HZT-L	Copper Alloy	Post-Sn	1 1 1 1
2	020 S SMT Tab TML HZT	Copper Alloy	Post-Sn	10 10 10 10
1	020_S_BL_SMT_10M_H_HSG_GN	PA9T-GF30	© Green	1 - - -
	020_S_BL_SMT_10M_H_HSG_RE	PA9T-GF30	© Red	- 1 - -
	020_S_BL_SMT_10M_H_HSG_BK	PA9T-GF30	Black	- - 1 -
	020_S_BL_SMT_10M_H_HSG_NR	PA9T-GF30	Natural	- - - 1

Part No.	Description
KH1700016-70	020_S_BL_SMT_10M_H_ASSY_GN
KH1700016-60	020_S_BL_SMT_10M_H_ASSY_RE
KH1700016-20	020_S_BL_SMT_10M_H_ASSY_BK
KH1700016-10	020_S_BL_SMT_10M_H_ASSY_NR

TOLERANCES UNLESS OTHERWISE SPECIFIED	UNIT MM
0 ±	THD ANGLE PROJECTION
0.0 ±	
0.00 ±	
0.000 ±	
0.0000 ±	
ANGLES ±	
PRODUCT SPEC	APPLICATION SPEC

DRWN JK. HWANG	NAME
CHKD KH. PARK	020_S_BL_SMT_10M_H_ASSY
APVD CY. CHOI	CUSTOMER DRAWING
MATERIAL SEE TABLE	DRAWING NO KH1700016
FINISH/COLOR SEE TABLE	LOC RESTRICTED TO
WEIGHT	SIZE A3
	SCALE 3:1
	SHEET 1 OF 1
	REV B

(주)우주 일렉트로닉스 UJU Electronics co.,Ltd.	
NAME	
020_S_BL_SMT_10M_H_ASSY	
CUSTOMER DRAWING	DRAWING NO
	KH1700016
LOC RESTRICTED TO	SIZE A3
	SCALE 3:1
	SHEET 1 OF 1
	REV B