

# PCB PATTERN

REV	REVISION RECORD	DATE	DRWN	CHKD	APVD
A	REVISED(RD-2018-009)	30.JAN'18	KH	-	CY

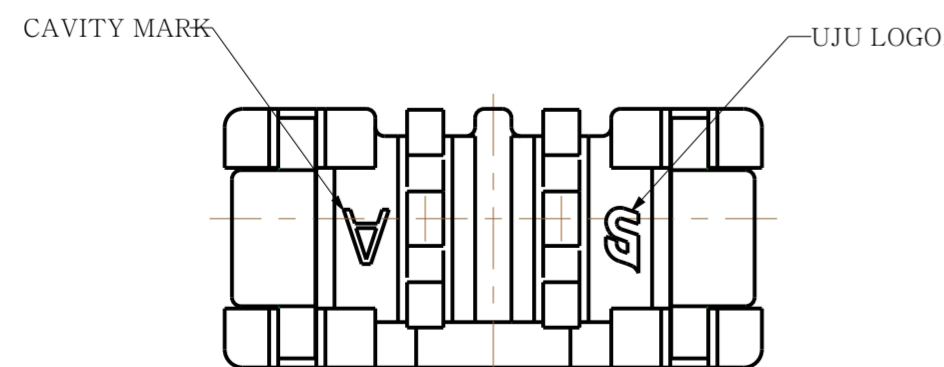
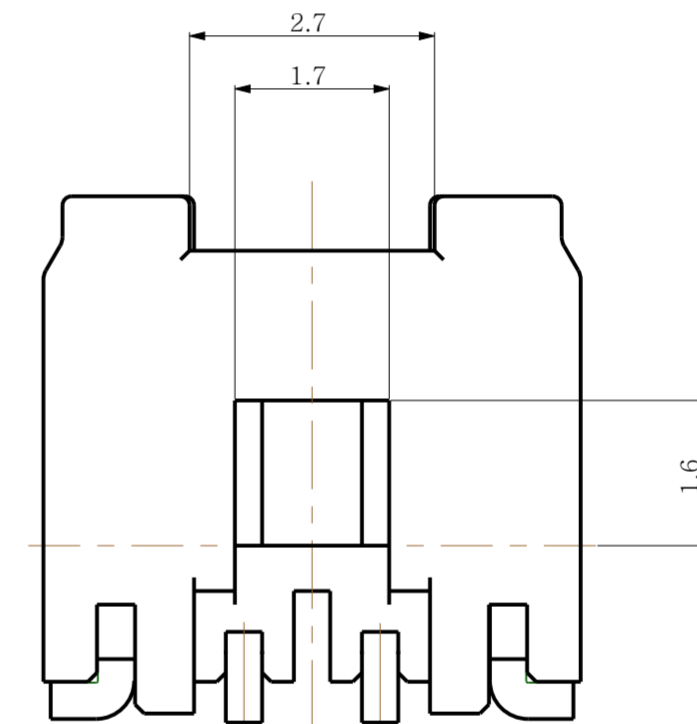
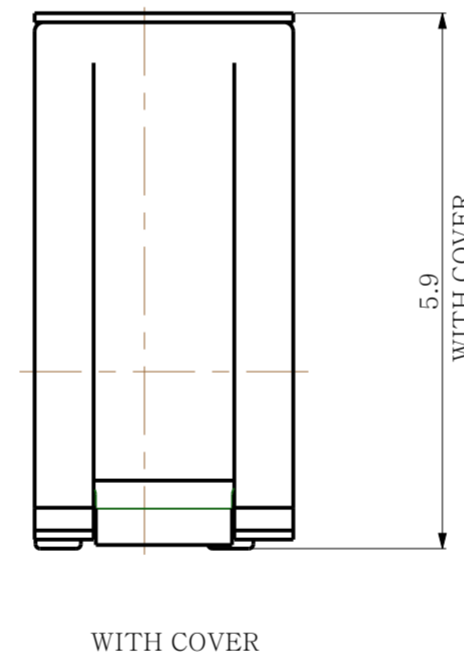
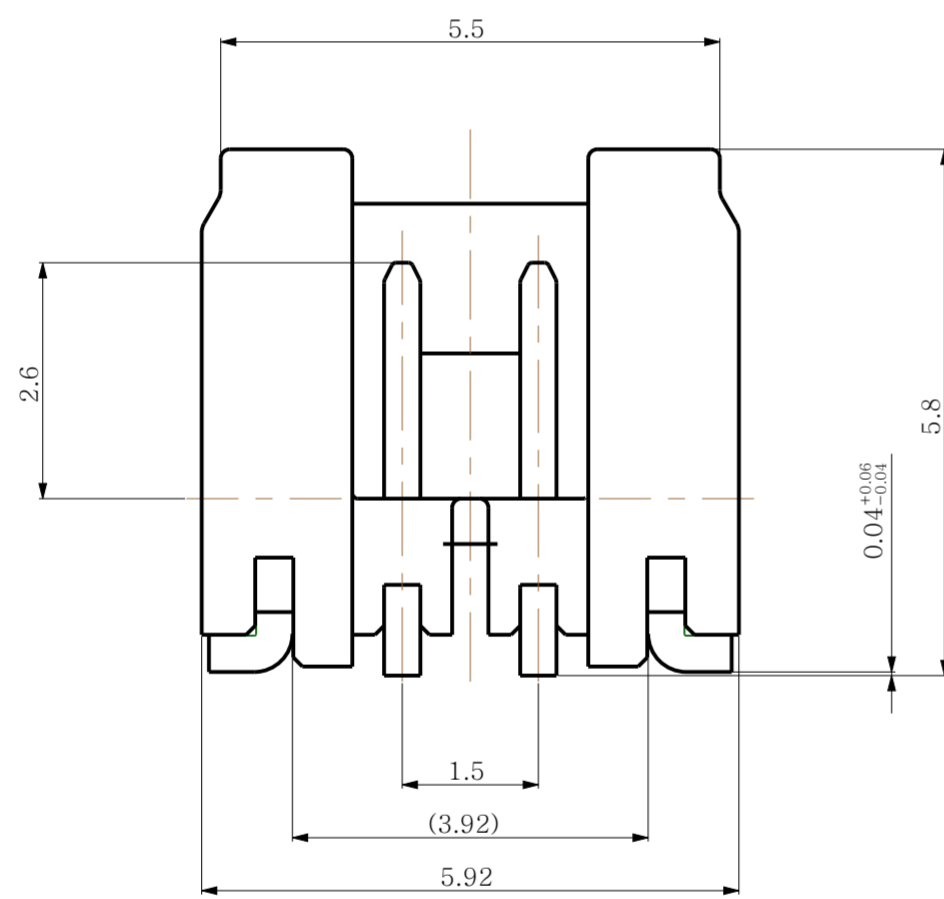
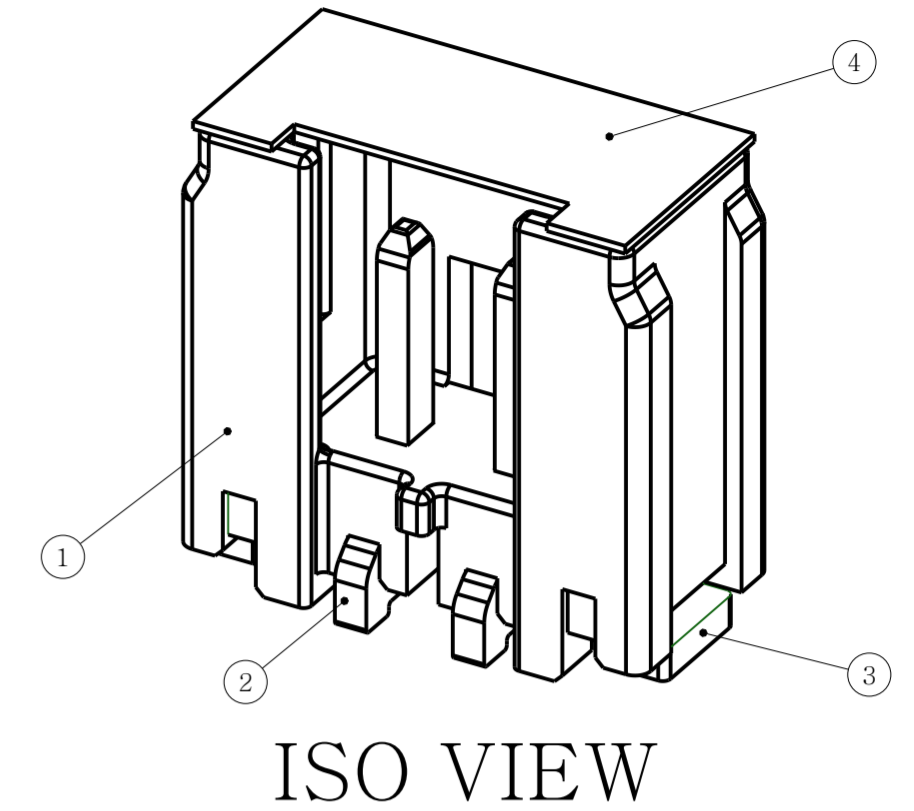
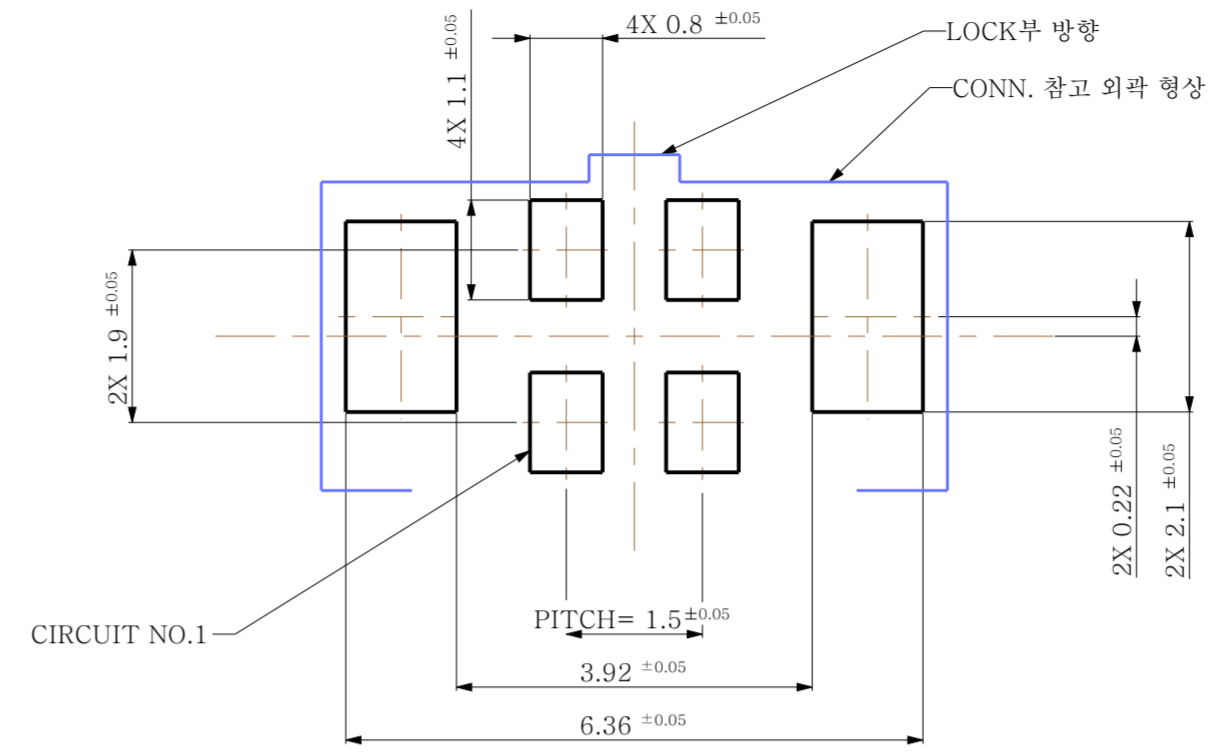
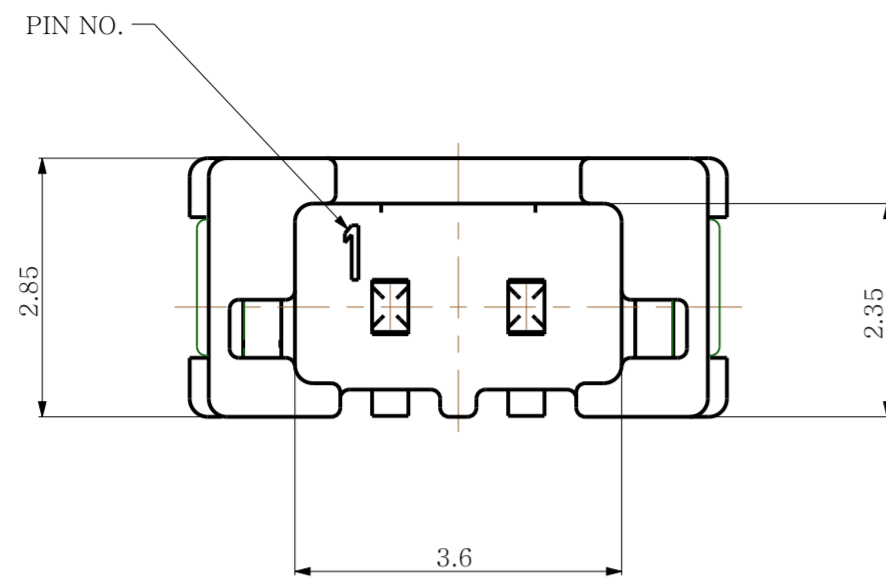

ASSY PART NO.	ASSY PART NAME	COLOR
KH1600053-20	015 SMT 2M HDR ASSY (V) BK	BLACK
KH1600053-10	015 SMT 2M HDR ASSY (V) NR	NATURAL

NO.	DESCRIPTION	PART NO.	MATERIAL	FINISH/COLOR	Q'TY
4	015 COVER TAPE	KN2000001	내열 TAPE		1
3	015 SMT SOLDER PEG-L (VTC)	KM1600056-21	BRASS	POST-TIN	1
	015 SMT SOLDER PEG-R (VTC)	KM1600056-20	BRASS	POST-TIN	1
2	015 SMT TAB TML (V)	KM1600055-20	BRASS	POST-TIN	2
1	015 SMT 2M HDR HSG (V)	KM1600054-20	PA9T-GF33	BLACK	1
	015 SMT 2M HDR HSG (V)	KM1600054-10	PA9T-GF33	NATURAL	1

TOLERANCE								
10MAX	30MAX	50MAX	70MAX	100MAX	120MAX	250MAX	250VR	ANGLE
±0.15	±0.20	±0.30	±0.40	±0.50	±0.75	±0.9	±1.4	±0.5도

- NOTE
- General Tolerance : see table tolerance
  - HSG DESCRIPTION : SEE TABLE
  - MATERIAL
    - HDR HSG : PA9T
    - SOLDER PEG : COPPER ALLOY (POST-TIN)
    - TAB TML : COPPER ALLOY (POST-TIN)

TOLERANCES UNLESS OTHERWISE SPECIFIED	UNIT MM	THIRD ANGLE PROJECTION
0		
0.0		
0.00		
0.000		
0.0000		
ANGLES		
PRODUCT SPEC	APPLICATION SPEC	WEIGHT

DRWN KH.PARK  
CHKD -  
APVD CY.CHOI

(주)우주 일렉트로닉스  
UJU Electronics co.,Ltd.

NAME 015 SMT 2M HDR ASSY (V)

CUSTOMER DRAWING NO. KH1600053

LOC RESTRICTED TO SIZE SCALE SHEET REV  
A2 12:1 1 OF 1 A