

REV	REVISION RECORD	DATE	DRWN	APVD
B	REVISED(KRD-2013-031)	11DCT'13	BW	SJ
B1	REVISED(KRD-2015-003)	22JAN'15	BW	SJ
C	REVISED(KRD-2016-012)	14JUN'16	CH	SJ

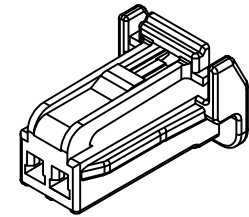

ISO VIEW

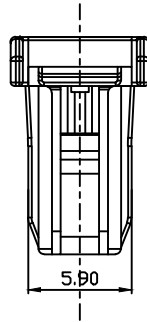

5.90

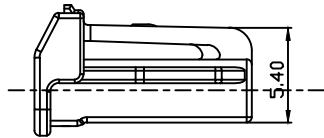

5.40

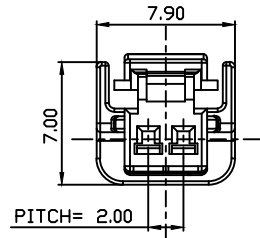

7.90

7.00

PITCH= 2.00

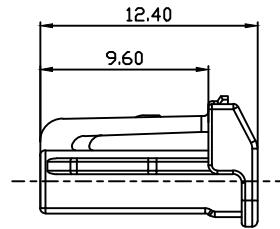

12.40

9.60

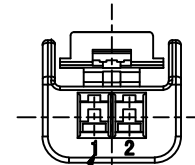

CIRCUIT NO.

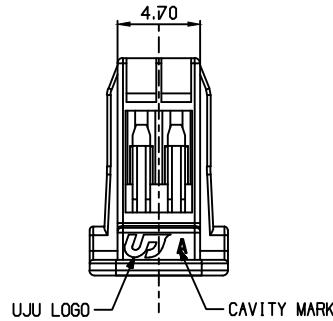

4.70

UJU LOGO

CAVITY MARK

TABLE-2 ©

020 REC(L)	KH1200030-22	COPPER ALLOY	0.5
020 REC(M)	KH1200030-21	COPPER ALLOY	0.3 ~ 0.35
DESCRIPTION	P/N	MATERIAL	WIRE SIZE (mm ²)

NOTE

1. GENERAL TOLERANCE : $\pm 0.3, \pm 3.0^\circ$
2. HSG DESCRIPTION : SEE TABLE-1
3. APPLICABLE RECEPTACLE : SEE TABLE-2

TABLE-1 ©

DESCRIPTION	P/N	Pos	MATERIAL/COLOR
020 2F HSG	KH1200012-40	2	PBT-GF10/BROWN
	KH1200012-20	2	PBT-GF10/BLACK
	KH1200012-10	2	PBT-GF10/NATURAL

TOLERANCES UNLESS OTHERWISE SPECIFIED	UNIT MM
0 0.0 0.00 0.000 ANGLES	THIRD ANGLE PROJECTION
PRODUCT SPEC	APPLICATION SPEC

DRWN CH.PARK	DATE 11DCT'13	APVD SJSJONG	NAME 020 2F HSG
CHKD CY.CHOI	MATERIAL SEE TABLE-1	FINISH/COLOR SEE TABLE-1	CUSTOMER DRAWING
UJU (주)우주일렉트로닉스 UJU Electronics co.,Ltd.	WEIGHT	DRAWING NO KH1200012	REV C
LDC / RESTRICTED TO	SCALE 5/1	SHEET 1 of 1	REV C