

# Board To Board Connector

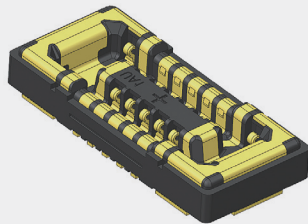

**Applications** | Smart Phone, Smart Watch, Tablet PC, Mobile Devices, Wearable Devices



Female

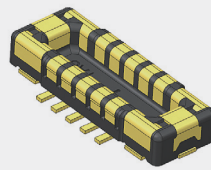

Male

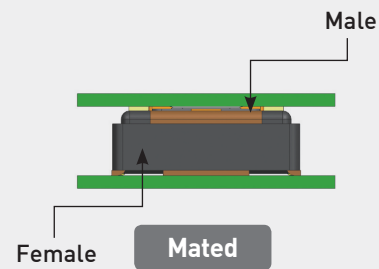

Female

Mated

- ▶ For contact stability, Double Contact and Bellows Type Contact Structure
- ▶ 0.35mm pitch, 0.8mm slim stacking design for saving space
- ▶ Functional Fitting Nail
  - 1) Robust type (Mold Prevention of damage)
  - 2) High Current
- ▶ Female , Male – Terminal / Fitting Nail Full-Insert Structure
  - 1) Prevention of Base damage and Reinforcement of strength
  - 2) Improving product quality reliability.

## Code & Specification

Mating Size / Unit : (mm)

Product Code	Pitch (mm)	No. of Contacts	Width (mm)	Height (mm)	Length	Remark
BF035-I10B-C08-H	10	0.35	2.20	0.80	4.85	Receptacle
BM035-I10B-C08-H	10	0.35	2.20	0.80	4.85	Plug

Rated Current	Contact Resistance	Withstanding voltage	Temperature Range
Signal 0.3A/Pin Power 5.0A/Pin	Signal 50mΩ [Max.] Power 10mΩ [Max.]	500V AC (RMS)	-35°C ~ 85°C

# Board To Board Connector



**Applications** | Smart Phone, Smart Watch, Tablet PC, Mobile Devices, Wearable Devices

## Product Specification

Ratings	Rated current	Signal : 0.3A/Pin Power : 5.0A/Pin	Operating temperature range	-35°C to +85°C 1	Storage temperature range	+15°C to +35 °C
	Rated voltage	30V AC(RMS) / DC	Operating humidity range	70%RH Max.2	Storage humidity range	65%RH Max. 2

1) Including terminal temperature rise.

2) Storage area is to be free of corrosive gases and dew formation.

Items	Specifications	Conditions
1. Contact resistance	- Signal : 50mΩ [Max.] - Power : 30mΩ [Max.]	- Open circuit voltage: 20mV (AC) - Test current: 1mA.
2. Insulation resistance	50MΩ [Min.]	500V DC
3. Withstanding voltage	No flashover or dielectric breakdown	500V AC(RMS) for 1minute
4. Insertion force / Separation force	1) Insertion force : 5.0kgf [Max.] 2) Separation force : 0.012kgf/Pin [Min]	Insert and withdraw connectors at the speed rate of 25mm per minute.
5. Durability	1) Contact resistance - Signal : 90mΩ [Max.] - Power : 50mΩ [Max.]	When mated up to 30 cycles repeatedly by the rate of 10mm per minute
6. Vibration	1) Discontinuity : 1.0 microsec. [Max.] 2) Contact resistance - Signal : 90mΩ [Max.] - Power : 50mΩ [Max.]	- Vibration frequency range : 10~55Hz - Total amplitude : 1.5mm - Sweep ration : 10-55-10Hz/Min - Duration : 2h each (6h in total)
7. Shock	1) Discontinuity : 1.0 microsec. [Max.] 2) Contact resistance - Signal : 90mΩ [Max.] - Power : 50mΩ [Max.]	- Acceleration : 50G (490m/s <sup>2</sup> ) - Duration : 11ms - Number of shocks : 3 times per each direction - Test current : 100mA
8. Humidity	1) Contact resistance - Signal : 90mΩ [Max.] - Power : 50mΩ [Max.] 2) Insulation resistance : 25MΩ [Min.]	- Temperature : 40°C±2°C - Relative humidity : 90% RH to 95% RH - Duration : 96hr

9. Solder heat resistance No loose contacts no deformation.

Reflow condition.  
(Refer to Reflow)

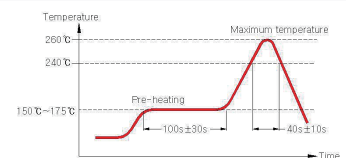

## Materials / Finish

Part	Materials	Finish	UL Regulation
Female Base	LCP	Black	UL94V-0
Female Terminal	Phosphor Bronze	Au, Ni plated	-
Female Fitting Nail	Copper Alloy	Au, Ni plated	-
Male Base	LCP	Black	UL94V-0
Male Terminal	Phosphor Bronze	Au, Ni plated	-
Male Fitting Nail	Copper Alloy	Au, Ni plated	-

# Board To Board Connector

**BT**

**Applications** | Smart Phone, Smart Watch, Tablet PC, Mobile Devices, Wearable Devices

## FEATURES AND ADVANTAGES

- ▶ Double Contact point for stable contact preservation



- ▶ Full-Insert Structure for prevention of Base damage

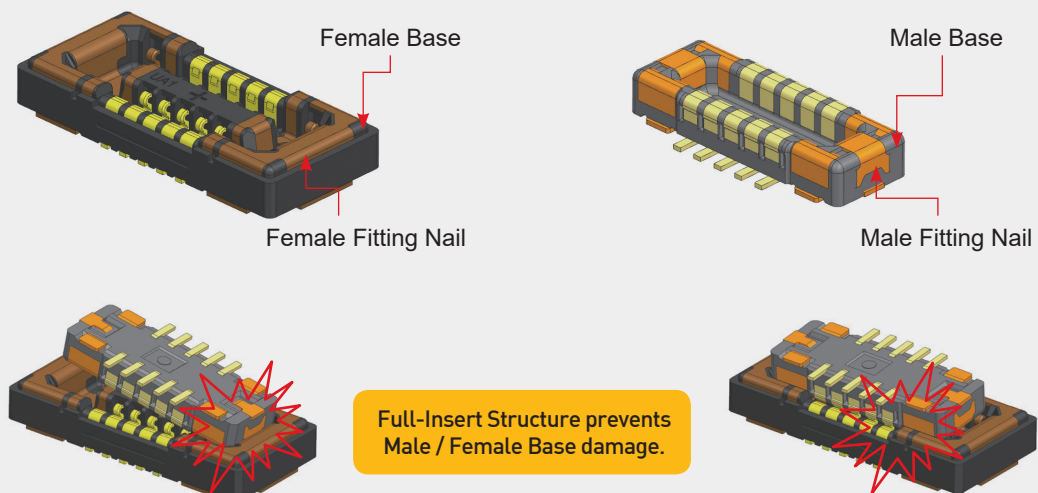

# Board To Board Connector



Applications | Smart Phone, Smart Watch, Tablet PC, Mobile Devices, Wearable Devices

## TYPE : RECEPTACLE (FEMALE)

### Product Drawing

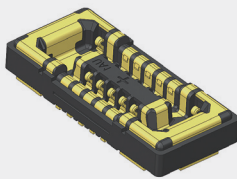

Female (Receptacle)

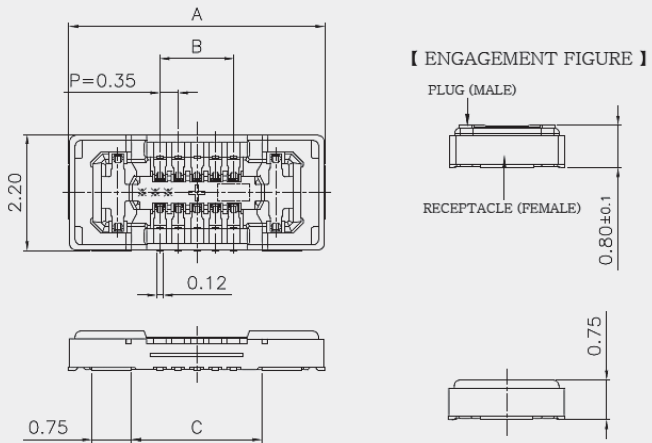

### Recommended PCB , Metal Mask Layout

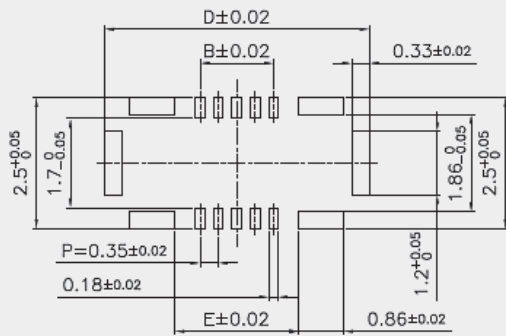

RECOMMENDED PAD LAYOUT

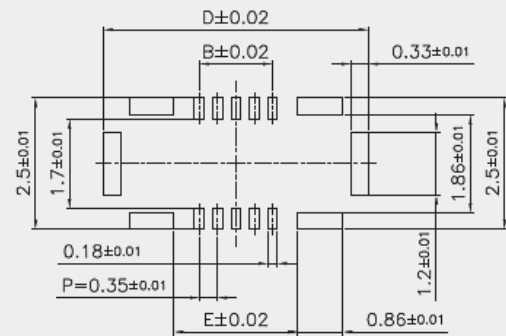

RECOMMENDED METAL MASK DIMENSION

(Metal Mask Thickness 80μm)

Mating Size / Unit : (mm)

Product No.	No. of Contacts	A	B	C	D	E
BF035-I10B-C08-H	10	4.85	1.40	2.47	5.05	2.36

# Board To Board Connector



Applications | Smart Phone, Smart Watch, Tablet PC, Mobile Devices, Wearable Devices

## TYPE : PLUG (MALE)

### Product Drawing

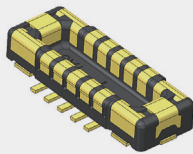

Male (Plug)

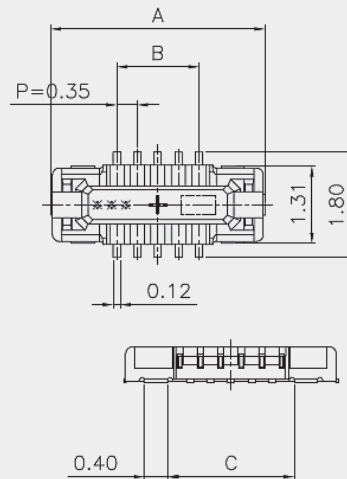

### 【 ENGAGEMENT FIGURE 】

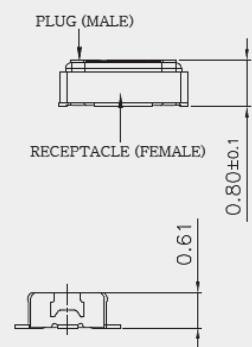

### Recommended PCB , Metal Mask Layout

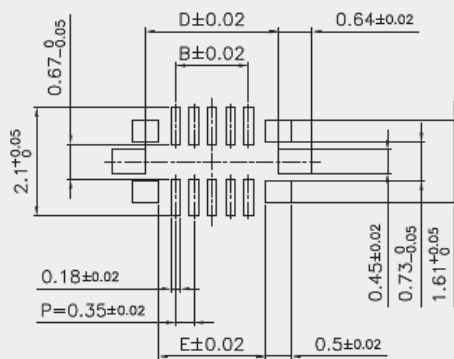

RECOMMENDED PAD LAYOUT

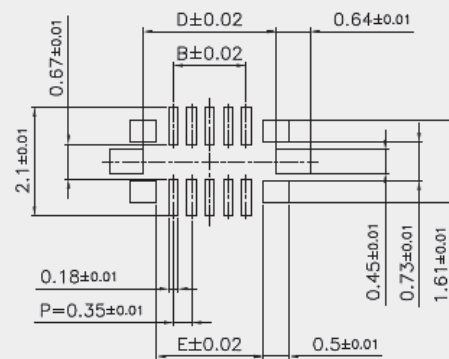

RECOMMENDED METAL MASK DIMENSION

(Metal Mask Thickness 80 $\mu$ m)

Mating Size / Unit : (mm)

Product No.	No. of Contacts	A	B	C	D	E
BM035-I10B-C08-H	10	3.65	1.40	2.15	2.57	2.05